

HW-102A-FU InSb Hall Element

- Ultra High-sensitivity InSb Hall element
- Classic SOT Package
- Shipped in packet-tape reel (2,000pcs per reel)

Absolute Maximum Rating

Operating Temperature Range	-40°C ~ 125°C
Storage Temperature Range	-55°C ~ 150°C
Maximum Input Current I_{cmax}	20mA
Maximum Input Voltage V_{cmax}	2V

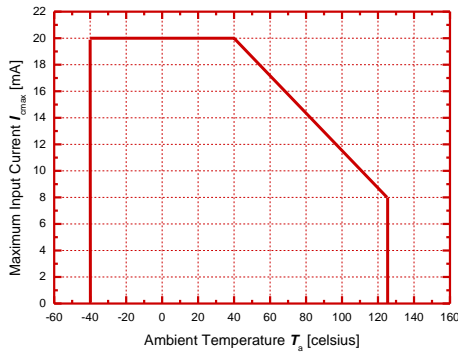

Figure 1.1 Maximum Input Current I_{cmax}

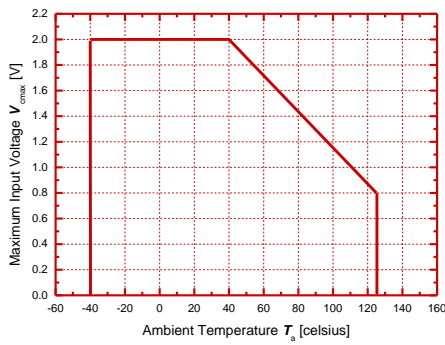
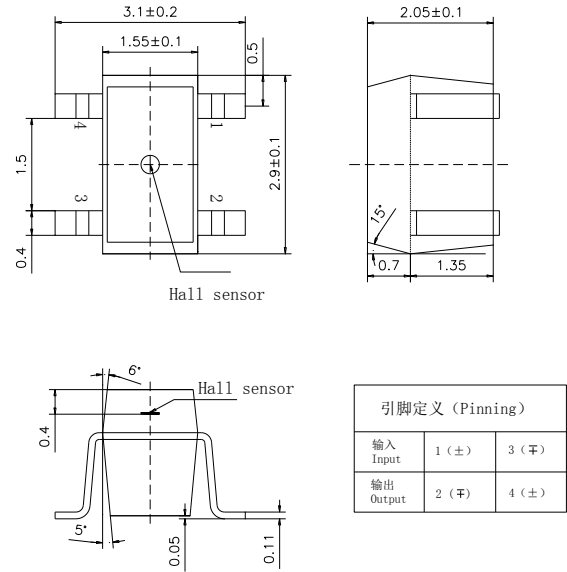

Figure 1.2 Maximum Input Voltage V_{cmax}

Dimensional Drawing (Unit: mm)



Electrical Characteristics (RT=25°C)

Table 1. Electrical Characteristics of HW-102A-FU

Item	Symbol	Test Condi.	Min.	Typ.	Max.	Unit
Hall Voltage	V_{H1}	$B = 50mT, V_C = 1V$ $T_a = RT$	196		465	mV
Input Resistance	R_{in}	$B = 0mT, I_C = 0.1mA$ $T_a = RT$	250		550	Ω
Output Resistance	R_{out}	$B = 0mT, I_C = 0.1mA$ $T_a = RT$	250		550	Ω
Offset Voltage	V_{os}	$B = 0mT, V_C = 1V$ $T_a = RT$	-7		+7	mV
Temp. Coeff. of V_{H1}	αV_{H1}	$B = 50mT, I_C = 5mA,$ $T_a = 0^\circ C \sim 40^\circ C$		-1.8		%/°C
Temp. Coeff. of R_{in}	αR_{in}	$B = 0mT, I_C = 0.1mA,$ $T_a = 0^\circ C \sim 40^\circ C$		-1.8		%/°C

Note:

$$1. \quad V_H = V_{H-M} - V_{os}$$

In which V_{H-M} is the Output Hall Voltage, V_H is the Hall Voltage and V_{os} is the offset Voltage under the identical electrical stimuli.

$$2. \quad \alpha V_H = \frac{1}{V_H(T_1)} \times \frac{V_H(T_3) - V_H(T_2)}{(T_3 - T_2)} \times 100$$

$$3. \quad \alpha R_{in} = \frac{1}{R_{in}(T_1)} \times \frac{R_{in}(T_3) - R_{in}(T_2)}{(T_3 - T_2)} \times 100$$

$$T_1 = 20^\circ C, \quad T_2 = 0^\circ C, \quad T_3 = 40^\circ C$$

Classification of Output Hall Voltage (V_H)

Table 2. Classification of Hall Voltage

Rank	V_H [mV]	Conditions
D	196 ~ 236	B=50mT, $V_C=1V$
E	228 ~ 274	
F	266 ~ 320	
G	310 ~ 370	
H	360 ~ 415	
I	405 ~ 465	

Characteristic Curves

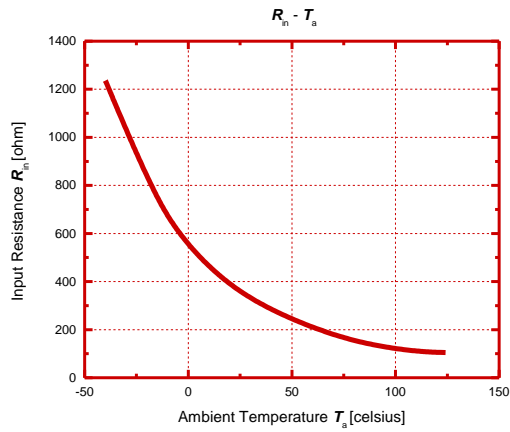

Figure 2. Input resistance R_{in} as a function of ambient temperature T_a .

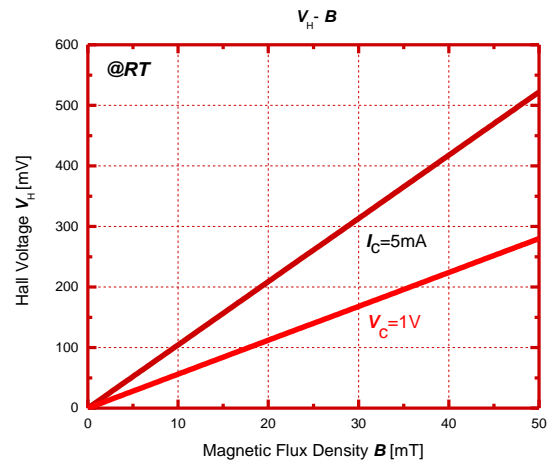

Figure 3. Hall voltage V_H as a function of magnetic flux density B .

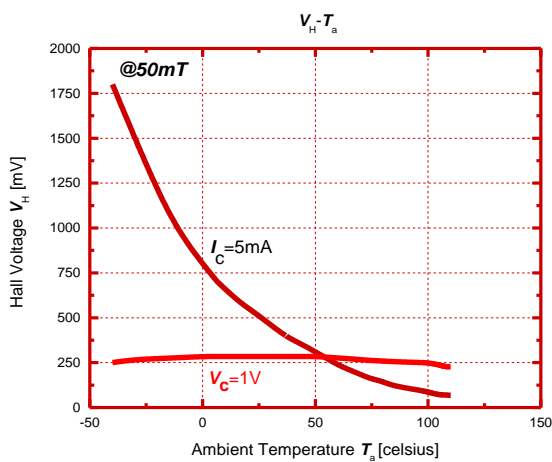

Figure 4. Hall voltage V_H as a function of ambient temperature T_a .

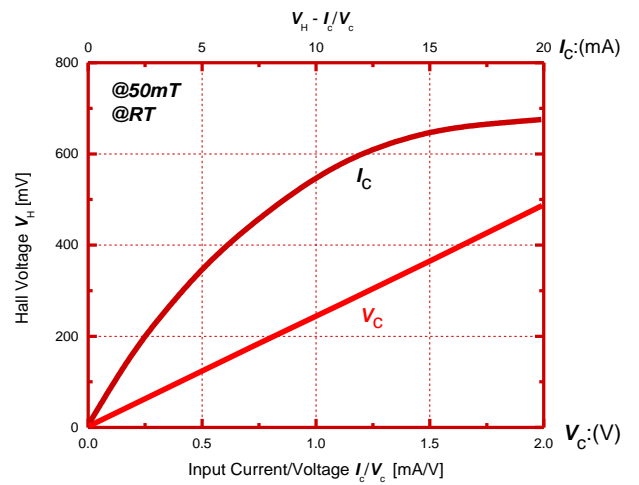

Figure 5. Hall voltage V_H as a function of electrical stimuli I_e/V_C .

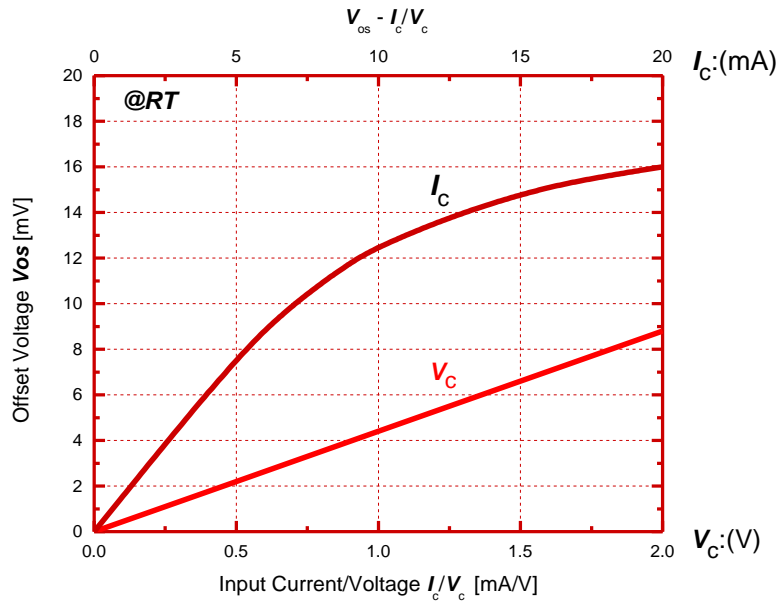

Figure 6. Offset voltage V_{OS} as a function of electrical stimuli I_C/ V_C .

Reliability Test Terms

Table 2. Reliability Test Terms, Conditions and Duration.

No.	Terms	Conditions	Duration
1	High Temperature Storage (HTS)	【JEITA EIAJ ED-4701】 $T_a=150$ (0 ~ +10) °C	1000 hrs
2	Heat Cycle (HC)	【JEITA EIAJ ED-4701】 $T_a=-55^{\circ}\text{C} \sim 150^{\circ}\text{C}$ high temp. - normal temp. - low temp. 30 min - 5 min - 30 min	30 cycles
3	Temp. Humidity Storage (THS)	【JEITA EIAJ ED-4701】 $T_a=85 \pm 3^{\circ}\text{C}$, $R_H=85 \pm 5\%$	1000 hrs
4	Reflow Soldering (RS)	【JEITA EIAJ ED-4701】 $260 \pm 5^{\circ}\text{C}$	10 sec
5	High Temp. Operating (HTO)	$T_a=125^{\circ}\text{C}$, $V_C=1\text{V}$	1000 hrs

Criteria:

- Variation of Hall Voltage V_H and input/output resistances $R_{in/out}$ are less than 20%.
- Variation of offset voltage V_{OS} is less than $\pm 16\text{mV}$.
- Other parameters in **Table 1.** are still within their ranges stated in **Table 1.**

Soldering Conditions

The following conditions should be preserved. Solder ability should be checked by yourself, because it is depend on solder paste material and other parameters.

Material of solder flux

- Use the resin based flux and refrain from using organic or inorganic acid based and water-soluble one.

Cleansing of solder flux conditions

- Use Ethanol or Isopropyl alcohol as cleansing material.
- Process temperature should be 50 °C or less.
- Duration should be 5 minutes or less.

Hand soldering conditions

- Apart from the mold resin more than 1mm.
- Solder at temperature 300 °C for less than 5s.

Wave soldering conditions

- Temperature in Pre-heating zone should be lower than 150°C.
- Temperature in Soldering zone should be lower than 270°C.

Precautions for ESD

This product is the device that is sensitive to ESD (Electrostatic Discharge). Handling Hall Elements with the ESD-Caution mark under the environment in which

- Static electrical charge is unlikely to arise (Ex: Relative Humidity over 40%RH).
- Wearing the anti-static suit and wristband when handling the devices.
- Implementing measures against ESD as for containers that directly touch the devices.

Precautions for Storage

- Products should be stored at an appropriate temperature and humidity (5° C to 35° C, 40%RH to 60%RH) after the unsealing of the MBB. Keeping products away from chlorine and corrosive gas.
- **For storage longer than 2 years**
Products are sealed in MBB with a desiccant. It is recommended to store in nitrogen atmosphere with MBB sealed. Oxygen and H₂O of atmosphere oxidizes leads of products and lead solder ability get worse.

Precautions for Safety

- Do not alter the form of this product into a gas, powder or liquid through burning, crushing or chemical processing.
- Observe laws and company regulations when discarding this product.