

## HW-102A InSb Hall Element

- Ultra High-sensitivity InSb Hall element
- Classic SOT Package
- Shipped in packet tape reel (2,000pcs per reel)

### Absolute Maximum Rating

Operating Temperature Range	-40°C ~ 125°C
Storage Temperature Range	-55°C ~ 150°C
Maximum Input Current $I_{cmax}$	20mA
Maximum Input Voltage $V_{cmax}$	2V

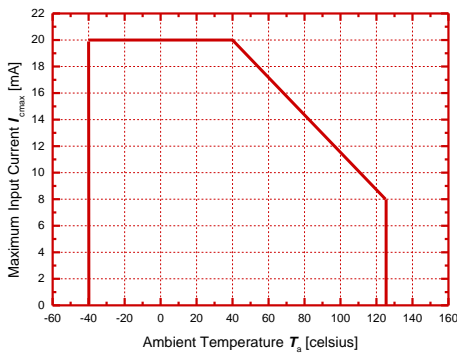

Figure 1.1 Maximum Input Current  $I_{cmax}$

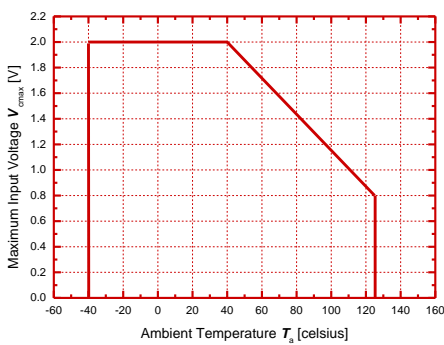
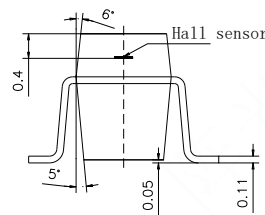
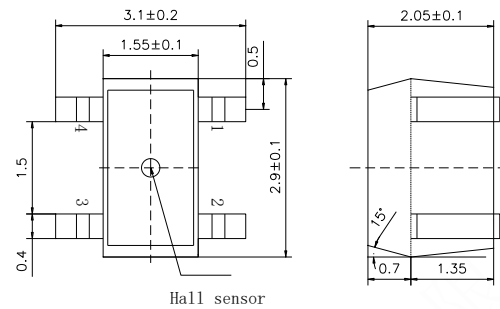

Figure 1.2 Maximum Input Voltage  $V_{cmax}$

### Dimensional Drawing (Unit: mm)



输入 Input	1 (±)	3 (∓)
输出 Output	2 (∓)	4 (±)

### Electrical Characteristics (RT=25°C)

Table 1. Electrical Characteristics of HW-102A

Item	Symbol	Test Condi.	Min.	Typ.	Max.	Unit
Hall Voltage	$V_H$	$B = 50mT, V_C = 1V$ $T_a = RT$	196		465	mV
Input Resistance	$R_{in}$	$B = 0mT, I_C = 0.1mA$ $T_a = RT$	250		550	$\Omega$
Output Resistance	$R_{out}$	$B = 0mT, I_C = 0.1mA$ $T_a = RT$	250		550	$\Omega$
Offset Voltage	$V_{os}$	$B = 0mT, V_C = 1V$ $T_a = RT$	-7		+7	mV
Temp. Coeff. of $V_H$	$\alpha V_H$	$B = 50mT, I_C = 5mA$ $T_a = 0^\circ C \sim 40^\circ C$		-1.8		%/ $^\circ C$
Temp. Coeff. of $R_{in}$	$\alpha R_{in}$	$B = 0mT, I_C = 0.1mA$ $T_a = 0^\circ C \sim 40^\circ C$		-1.8		%/ $^\circ C$

Note:

- $V_H = V_{H-M} - V_{os}$   
In which  $V_{H-M}$  is the Output Hall Voltage,  $V_H$  is the Hall Voltage and  $V_{os}$  is the offset Voltage under the identical electrical stimuli.

$$2. \alpha V_H = \frac{1}{V_H(T_1)} \times \frac{V_H(T_3) - V_H(T_2)}{(T_3 - T_2)} \times 100$$

$$3. \alpha R_{in} = \frac{1}{R_{in}(T_1)} \times \frac{R_{in}(T_3) - R_{in}(T_2)}{(T_3 - T_2)} \times 100$$

$$T_1 = 20^\circ C, \quad T_2 = 0^\circ C, \quad T_3 = 40^\circ C$$

## Classification of Output Hall Voltage ( $V_H$ )

Table 2. Classification of Hall Voltage

Rank	$V_H$ [mV]	Conditions
D	196 ~ 236	B=50mT, $V_C=1V$
E	228 ~ 274	
F	266 ~ 320	
G	310 ~ 370	
H	360 ~ 415	
I	405 ~ 465	

## Characteristic Curves

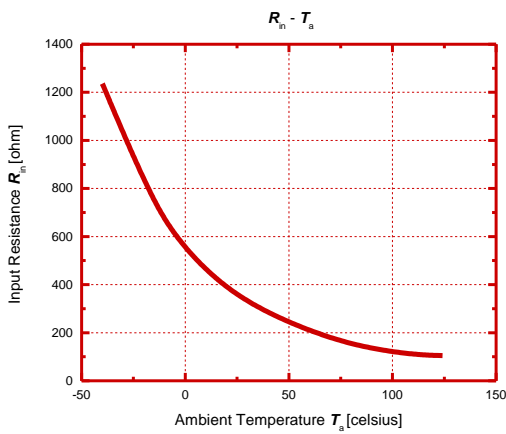

Figure 2. Input resistance  $R_{in}$  as a function of ambient temperature  $T_a$ .

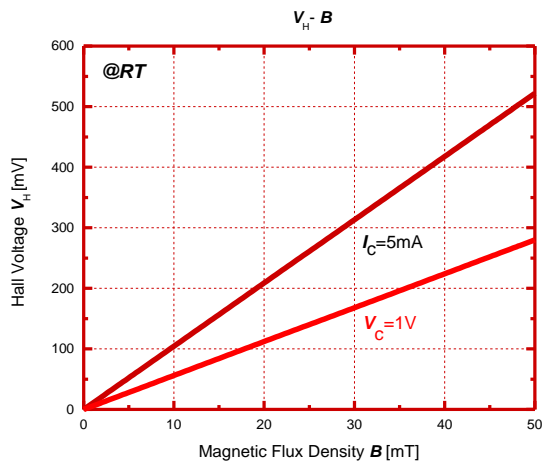

Figure 3. Hall voltage  $V_H$  as a function of magnetic flux density  $B$ .

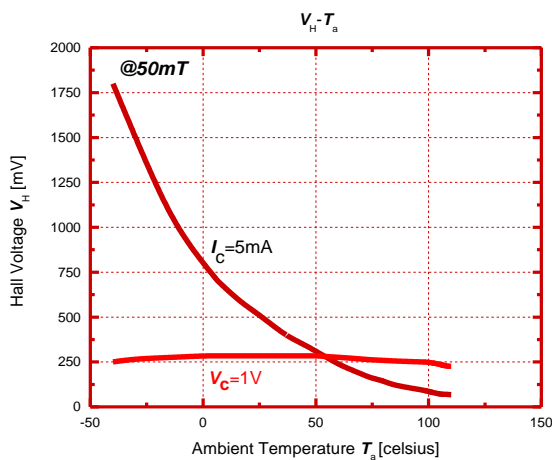

Figure 4. Hall voltage  $V_H$  as a function of ambient temperature  $T_a$ .

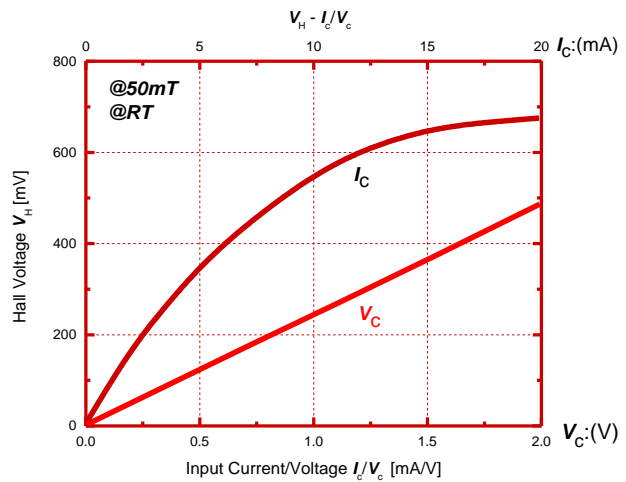

Figure 5. Hall voltage  $V_H$  as a function of electrical stimuli  $I_C/V_C$ .

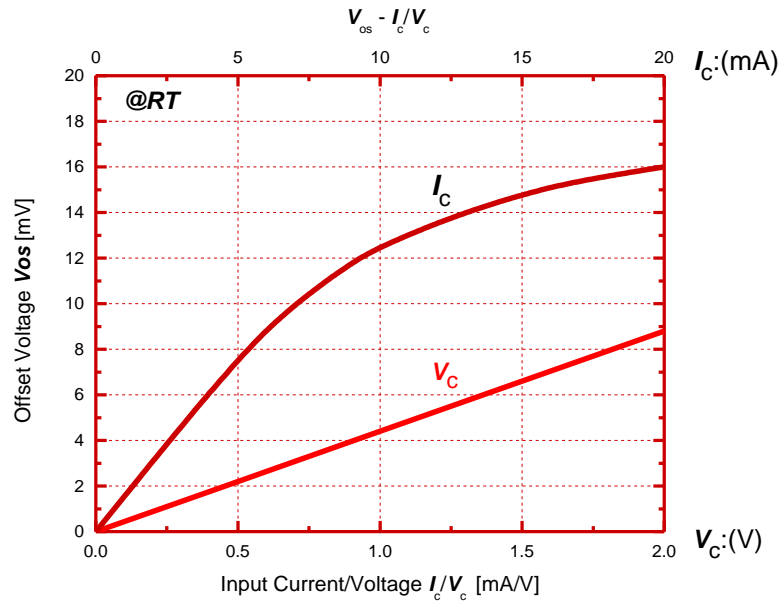

Figure 6. Offset voltage  $V_{os}$  as a function of electrical stimuli  $I_c/V_c$ .

## Reliability Test Terms

Table 2. Reliability Test Terms, Conditions and Duration.

No.	Terms	Conditions	Duration
1	High Temperature Storage (HTS)	【JEITA EIAJ ED-4701】 $T_a = 150 (0 \sim +10) \text{ } ^\circ\text{C}$	1000 hrs
2	Heat Cycle (HC)	【JEITA EIAJ ED-4701】 $T_a = -55^\circ\text{C} \sim 150 \text{ } ^\circ\text{C}$ high temp. - normal temp. - low temp. 30 min - 5 min - 30 min	30 cycles
3	Temp. Humidity Storage (THS)	【JEITA EIAJ ED-4701】 $T_a = 85 \pm 3 \text{ } ^\circ\text{C}$ , $R_H = 85 \pm 5 \%$	1000 hrs
4	Reflow Soldering (RS)	【JEITA EIAJ ED-4701】 $260 \pm 5 \text{ } ^\circ\text{C}$	10 sec
5	High Temp. Operating (HTO)	$T_a = 125 \text{ } ^\circ\text{C}$ , $V_c = 1\text{V}$	1000 hrs

Criteria:

- Variation of Hall Voltage  $V_H$  and input/output resistances  $R_{in/out}$  are less than 20%.
- Variation of offset voltage  $V_{os}$  is less than  $\pm 16\text{mV}$ .
- Other parameters in **Table 1.** are still within their ranges stated in **Table 1.**

## Soldering Conditions

---

The following conditions should be preserved. Solder ability should be checked by yourself, because it is depend on solder paste material and other parameters.

### Material of solder flux

---

- Use the resin based flux and refrain from using organic or inorganic acid based and water-soluble one.

### Cleansing of solder flux conditions

---

- Use Ethanol or Isopropyl alcohol as cleansing material.
- Process temperature should be 50 °C or less.
- Duration should be 5 minutes or less.

### Hand soldering conditions

---

- Apart from the mold resin more than 1mm.
- Solder at temperature 300 °C for less than 5s.

### Wave soldering conditions

---

- Temperature in Pre-heating zone should be lower than 150°C.
- Temperature in Soldering zone should be lower than 270°C.

## Precautions for ESD

---

This product is the device that is sensitive to ESD (Electrostatic Discharge). Handling Hall Elements with the ESD-Caution mark under the environment in which

- Static electrical charge is unlikely to arise (Ex: Relative Humidity over 40%RH).
- Wearing the anti-static suit and wristband when handling the devices.
- Implementing measures against ESD as for containers that directly touch the devices.

## Precautions for Storage

---

- Products should be stored at an appropriate temperature and humidity (5° C to 35° C, 40%RH to 60%RH) after the unsealing of the MBB. Keeping products away from chlorine and corrosive gas.
- **For storage longer than 2 years**  
Products are sealed in MBB with a desiccant. It is recommended to store in nitrogen atmosphere with MBB sealed. Oxygen and H<sub>2</sub>O of atmosphere oxidizes leads of products and lead solder ability get worse.

## Precautions for Safety

---

- Do not alter the form of this product into a gas, powder or liquid through burning, crushing or chemical processing.
- Observe laws and company regulations when discarding this product.