

HW-108A InSb Hall Element

- Ultra High-sensitivity InSb Hall Element
- Thin SOT Package
- Shipped in packet-tape reel (4,000pcs per reel)

Absolute Maximum Rating

Operating Temperature Range	-40°C ~ 125°C
Storage Temperature Range	-55°C ~ 150°C
Maximum Input Current I_{Cmax}	20mA
Maximum Input Voltage V_{Cmax}	2V

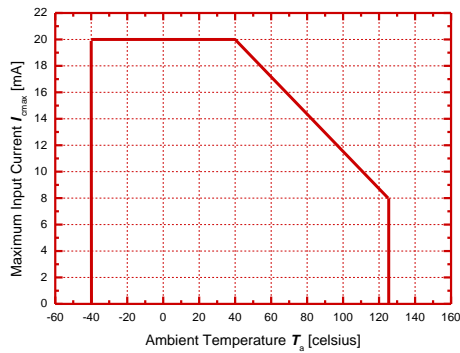

Figure 1.1 Maximum Input Current I_{Cmax}

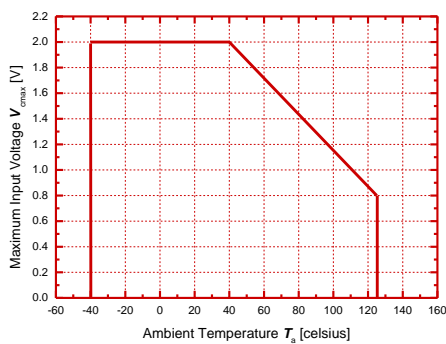
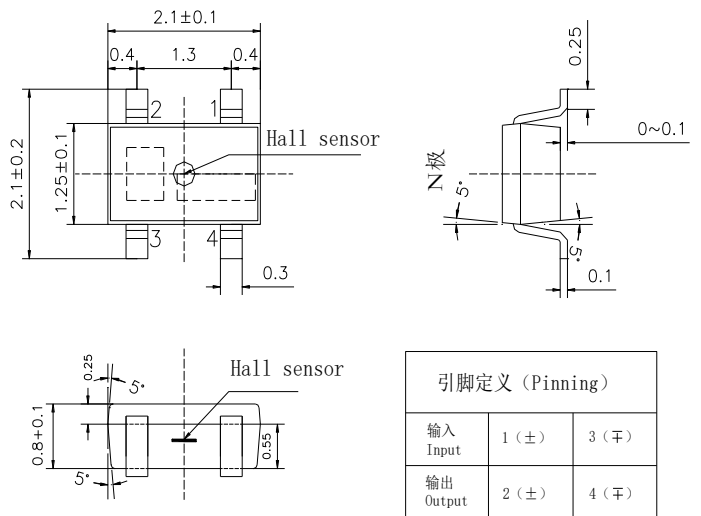

Figure 1.2 Maximum Input Voltage V_{Cmax}

Dimensional Drawing (Unit: mm)



Electrical Characteristics (RT=25°C)

Table 1. Electrical Characteristics of HW-108A

Item	Symbol	Test Condi.	Min.	Typ.	Max.	Unit
Hall Voltage	V_H	$B = 50mT, V_C = 1V$ $T_a = RT$	168		370	mV
Input Resistance	R_{in}	$B = 0mT, I_C = 0.1mA$ $T_a = RT$	250		550	Ω
Output Resistance	R_{out}	$B = 0mT, I_C = 0.1mA$ $T_a = RT$	250		550	Ω
Offset Voltage	V_{os}	$B = 0mT, V_C = 1V$ $T_a = RT$	-7		+7	mV
Temp. Coeff. of V_H	αV_H	$B = 50mT, I_C = 5mA,$ $T_a = 0^\circ C \sim 40^\circ C$		-1.8		%/°C
Temp. Coeff. of R_{in}	αR_{in}	$B = 0mT, I_C = 0.1mA,$ $T_a = 0^\circ C \sim 40^\circ C$		-1.8		%/°C

Note:

$$1. \quad V_H = V_{H-M} - V_{os}$$

In which V_{H-M} is the Output Hall Voltage, V_H is the Hall Voltage and V_{os} is the offset Voltage under the identical electrical stimuli.

$$2. \quad \alpha V_H = \frac{1}{V_H(T_1)} \times \frac{V_H(T_3) - V_H(T_2)}{(T_3 - T_2)} \times 100$$

$$3. \quad \alpha R_{in} = \frac{1}{R_{in}(T_1)} \times \frac{R_{in}(T_3) - R_{in}(T_2)}{(T_3 - T_2)} \times 100$$

$$T_1 = 20^\circ C, \quad T_2 = 0^\circ C, \quad T_3 = 40^\circ C$$

Classification of Output Hall Voltage (V_H)

Table 2. Classification of Hall Voltage

Rank	V_H [mV]	Conditions
C	168 ~ 204	B=50mT, $V_C=1V$
D	196 ~ 236	
E	228 ~ 274	
F	266 ~ 320	
G	310 ~ 370	

Characteristic Curves

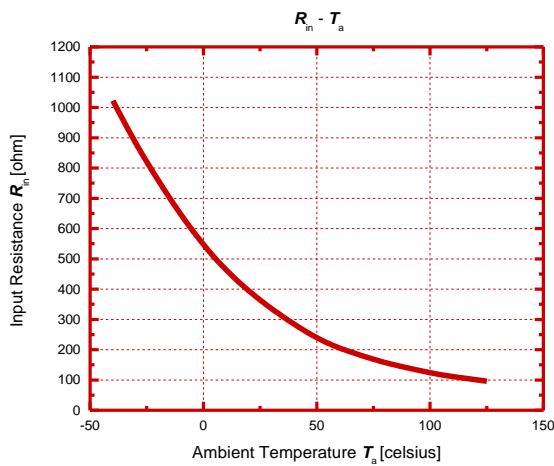

Figure 2. Input resistance R_{in} as a function of ambient temperature T_a .

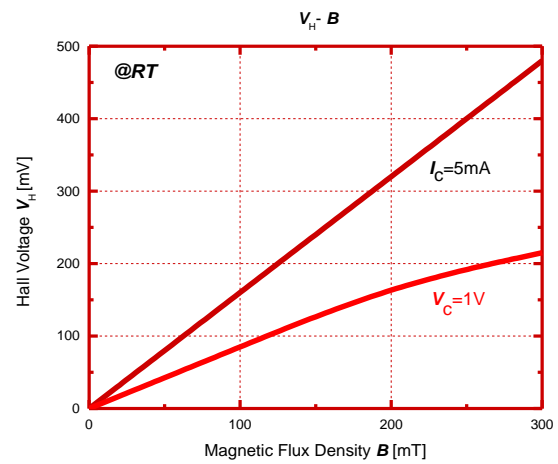

Figure 3. Hall voltage V_H as a function of magnetic flux density B .

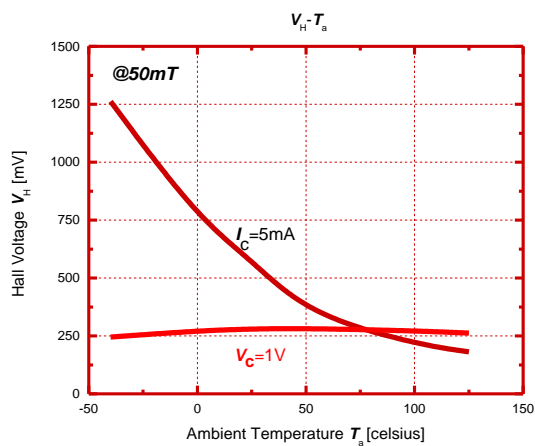

Figure 4. Hall voltage V_H as a function of ambient temperature T_a .

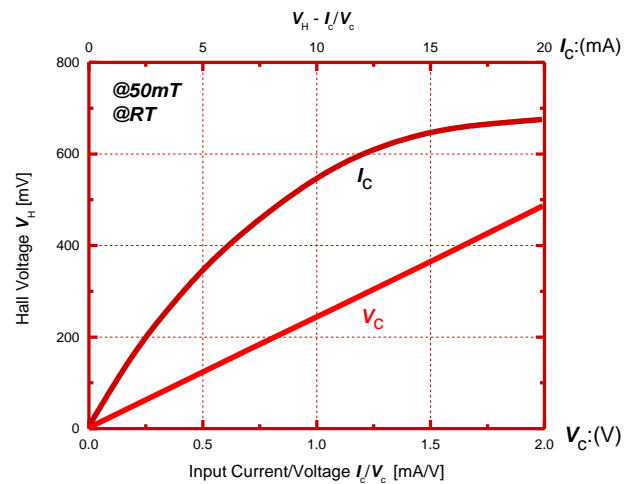

Figure 5. Hall voltage V_H as a function of electrical stimuli I_C/V_C .

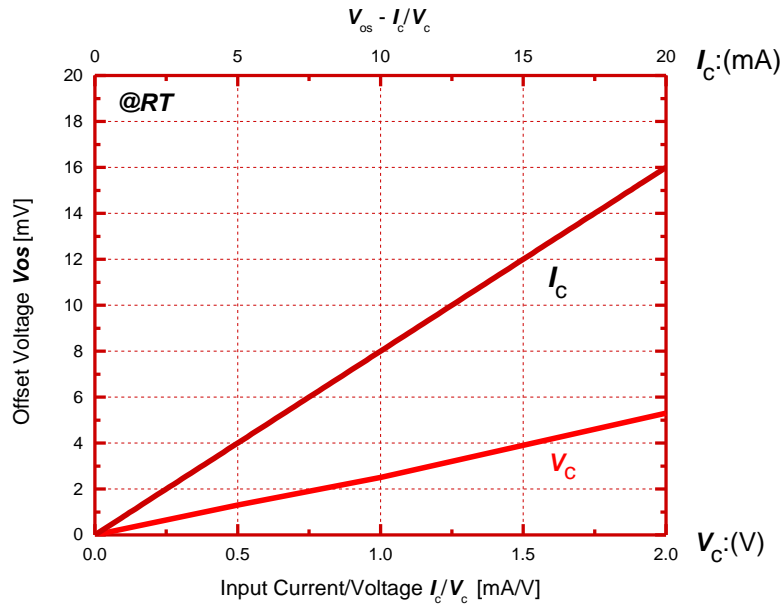

Figure 6. Offset voltage V_{os} as a function of electrical stimuli I_c/V_c .

Reliability Test Terms

Table 2. Reliability Test Terms, Conditions and Duration.

No.	Terms	Conditions	Duration
1	High Temperature Storage (HTS)	【JEITA EIAJ ED-4701】 $T_a = 150 (0 \sim +10) ^\circ\text{C}$	1000 hrs
2	Heat Cycle (HC)	【JEITA EIAJ ED-4701】 $T_a = -55^\circ\text{C} \sim 150 ^\circ\text{C}$ high temp. - normal temp. - low temp. 30 min - 5 min - 30 min	30 cycles
3	Temp. Humidity Storage (THS)	【JEITA EIAJ ED-4701】 $T_a = 85 \pm 3 ^\circ\text{C}$, $R_H = 85 \pm 5 \%$	1000 hrs
4	Reflow Soldering (RS)	【JEITA EIAJ ED-4701】 $260 \pm 5 ^\circ\text{C}$	10 sec
5	High Temp. Operating (HTO)	$T_a = 125 ^\circ\text{C}$, $V_c = 1\text{V}$	1000 hrs

Criteria:

- Variation of Hall Voltage V_H and input/output resistances $R_{in/out}$ are less than 20%.
- Variation of offset voltage V_{os} is less than $\pm 16\text{mV}$.
- Other parameters in Table 1. are still within their ranges stated in Table 1.

Soldering Conditions

The following conditions should be preserved. Solder ability should be checked by yourself, because it is depend on solder paste material and other parameters.

Material of solder flux

- Use the resin based flux and refrain from using organic or inorganic acid based and water-soluble one.

Cleansing of solder flux conditions

- Use Ethanol or Isopropyl alcohol as cleansing material.
- Process temperature should be 50 °C or less.
- Duration should be 5 minutes or less.

Hand soldering conditions

- Apart from the mold resin more than 1mm.
- Solder at temperature 300 °C for less than 5s.

Wave soldering conditions

- Temperature in Pre-heating zone should be lower than 150°C.
- Temperature in Soldering zone should be lower than 270°C.

Precautions for ESD

This product is the device that is sensitive to ESD (Electrostatic Discharge). Handling Hall Elements with the ESD-Caution mark under the environment in which

- Static electrical charge is unlikely to arise (Ex: Relative Humidity over 40%RH).
- Wearing the anti-static suit and wristband when handling the devices.
- Implementing measures against ESD as for containers that directly touch the devices.

Precautions for Storage

- Products should be stored at an appropriate temperature and humidity (5° C to 35° C, 40%RH to 60%RH) after the unsealing of the MBB. Keeping products away from chlorine and corrosive gas.
- **For storage longer than 2 years**
Products are sealed in MBB with a desiccant. It is recommended to store in nitrogen atmosphere with MBB sealed. Oxygen and H₂O of atmosphere oxidizes leads of products and lead solder ability get worse.

Precautions for Safety

- Do not alter the form of this product into a gas, powder or liquid through burning, crushing or chemical processing.
- Observe laws and company regulations when discarding this product.