



Parameter	Symbol	Rating	Units
Load Voltage	V _L	60	V
Load Current	I _L	1.1	A
On-Resistance	R _{on}	0.3	Ω
I/O Breakdown Voltage	V _{io}	5000	V _{rms}



SMD-6



DIP-6

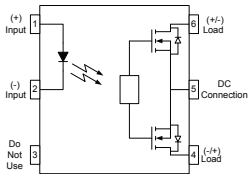

1. LED Anode
2. LED Cathode
4. Drain (MOS FET)
5. Source (MOS FET)
6. Drain (MOS FET)

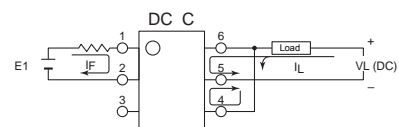
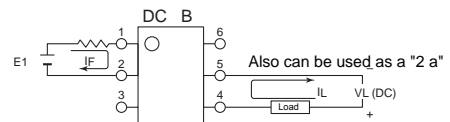
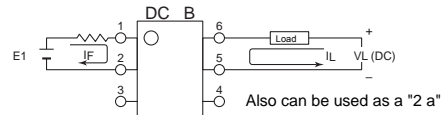
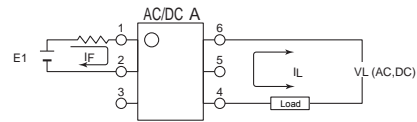

APSEMI PhotoRelays

APSEMI Photorelays are the most reliable, technically advanced logic-to-power interface devices. Their basic function is to take a low current signal from a microprocessor to control the switching of both AC and DC loads, while providing an isolation barrier between logic and power. While this function is common to all relays, Photorelays provide distinct advantages over their mechanical counterparts including:

- Long life (No limit on mechanical and electrical lifetime)
- Bounce-free switching
- Higher speed and high frequency switching
- Higher sensitivity (less power consumption)
- Immunity to EMI or RFI
- No have voltaic arc, bounce, and noise
- More resistant to vibration and impact
- AC or DC load switching
- Small package size

Applications

These advantages make APSEMI Photorelays the ideal choice for:

- Telecom/Datacom switching
- Multiplexers
- Meter reading systems
- Data acquisition
- Medical equipment
- Battery monitoring
- I/O Sub-Systems
- Robotics
- Aerospace
- Home/Safety security systems
- Process Control
- Energy Management
- Reed Relay EMR Replacement
- Programmable Controllers

TPYES

Category	Output Rating		Package	Part No.	Packing Quantity
	Load Voltage	Load Current			
AC/DC	60V	1.1A	DIP-6	APV212G1E	50pcs /tube
			SMD-6	APV212G1EH	1000pcs /reel

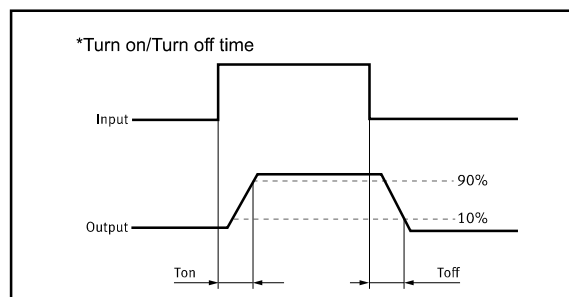

**Absolute Maximum Ratings** (Ta = 25°C)

Item		Symbol	Value	Units	Note
Input	Continuous LED Current	I_F	50	mA	
	Peak LED Current	I_{FP}	1000	mA	f=100Hz, duty=1%
	LED Reverse Voltage	V_R	5	V	
	Input Power Dissipation	P_{In}	75	mW	
Output	Load Voltage	V_L	60	V(AC peak or DC)	
	Load Current	I_L	1.1	A	
	Peak Load Current	I_{Peak}	3.0	A	100ms(1 pulse)
	Output Power Dissipation	P_{out}	380	mW	
Total Power Dissipation		P_T	450	mW	
I/O Breakdown Voltage		$V_{I/O}$	5000	Vrms	RH=60%, 1min
Operating Temperature		T_{opr}	-40 to 85	°C	
Storage Temperature		T_{stg}	-40 to 100	°C	
Pin Soldering Temperature		T_{sol}	260	°C	10 sec max.

Electrical Characteristics (Ta = 25°C)

Item		Symbol	MIN.	TYP.	MAX.	Units	Conditions
Input	LED Forward Voltage	V_F		1.2	1.4	V	$I_F=10mA$
	Operation LED Current	I_{Fon}		0.5	3.0	mA	
	Recovery LED Current	I_{Foff}		0.35	0.5	mA	
	Recovery LED Voltage	V_{Foff}	0.7			V	
Output	On-Resistance	R_{on}		0.3	0.7	Ω	$I_F=5mA, I_L=100mA,$ Time to flow is within 1 sec.
	Off-State Leakage Current	I_{Leak}			1.0	μA	$V_L=Rating$
	Output Capacitance	C_{out}		115		pF	$V_L=0, f=1MHz$
Transmis sion	Turn-On Time	T_{on}		0.5	5.0	ms	$I_F=5mA, I_L=100mA,$
	Turn-Off Time	T_{off}		0.35	2.0	ms	
Coupled	I/O Isolation Resistance	$R_{I/O}$	10^{10}			Ω	DC500V
	I/O Capacitance	$C_{I/O}$		0.8	1.5	pF	f=1MHz



Engineering Data

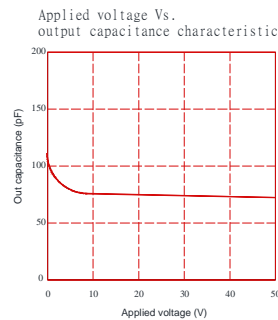
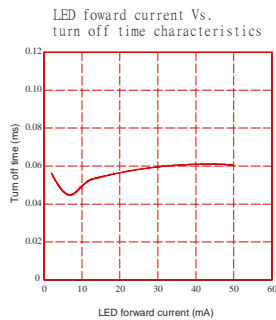
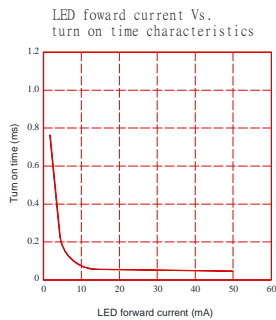
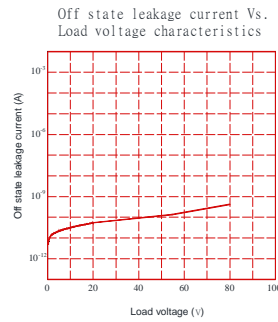
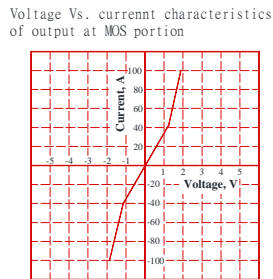
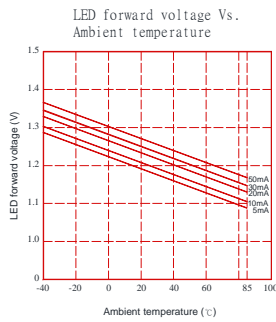
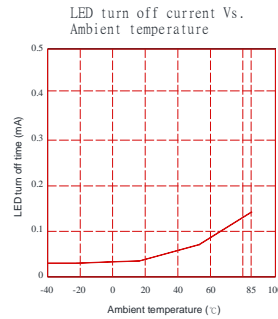
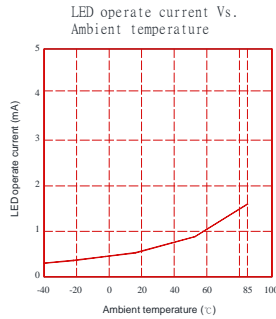
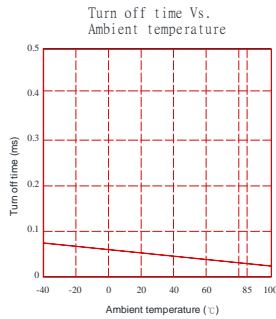
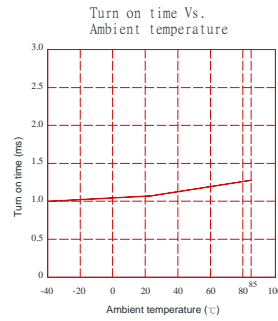
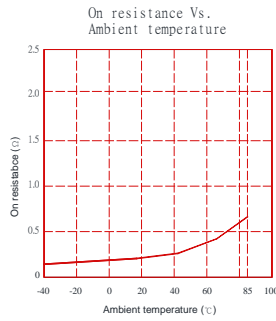
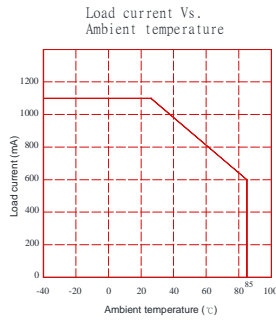



Dimensions and DIP-6 Package Unit: mm

Marking

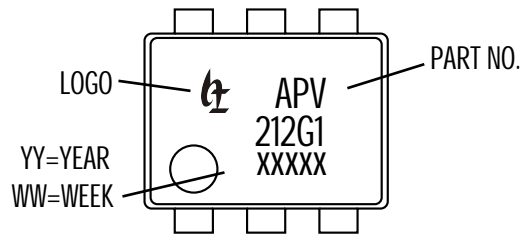

Lable



Through hole terminal type

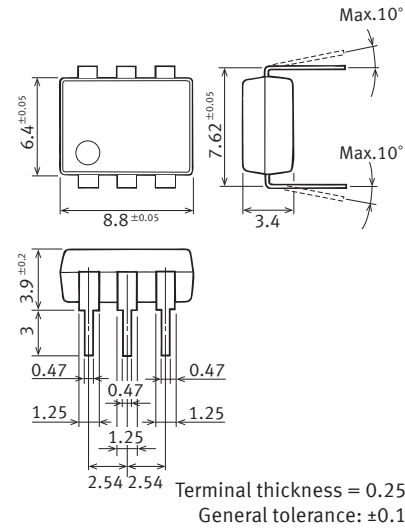

PC board pattern (Bottom view)

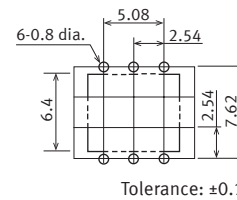

DIP Tape dimensions Unit: mm

Devices are packaged in a tube so that pin No. 1 is on the stopper B side. Observe correct orientation when mounting them on PC boards.





Dimensions and SMD-6 Package Unit: mm

Marking

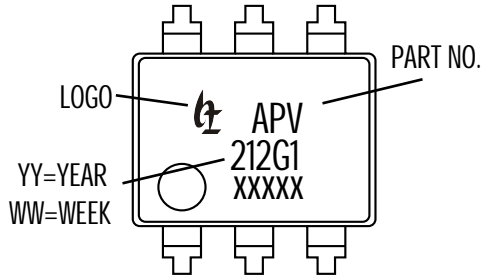

Surface mount terminal type

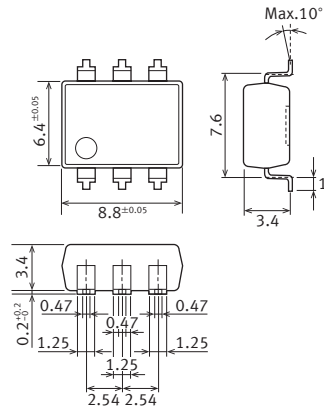

Terminal thickness = 0.25
General tolerance: ±0.1

Lable

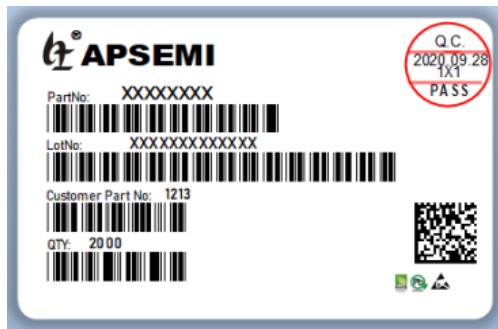

Recommended mounting pad (Top view)

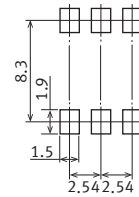

Tolerance: ±0.1

Tape dimensions (tape reel)

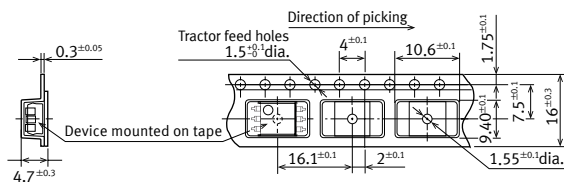
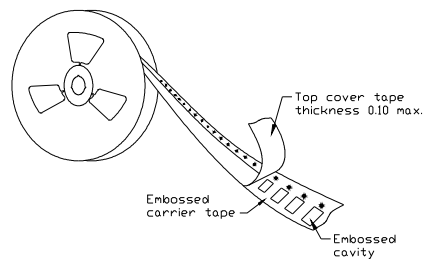
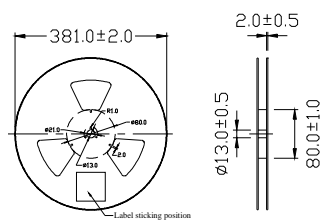



Using Methods

Examples of resistance value to control LED forward current ($I_F=5\text{mA}$)



E1	R1 (Approx)
3.3V	300 Ω
5.0V	600 Ω
12V	1.9K Ω
24V	4.1K Ω

LED forward current must be more than 5mA , at $I(\text{MIN})$,and less than 30mA , at $I(\text{MAX})$.



Recommended Operating Conditions

Please obey the following conditions to ensure proper device operation and resetting. Input LED current (Recommended value):

Characteristic	Symbol	Min	Typ.	Max	Unit
Forward current	I_F	5.0	7.0	30	mA

Protection Circuit

Output spike voltages:if an inductive load generates spike voltages which exceed heabsolute maximum rating, the spike voltage shall be limited.

Clamp diode is connected in parallel with the load.
Absorb capacity with external diode.

CR Snubber is connected in parallel with the load.
Absorb capacity with buffer capacity.



When adding diodes, buffer circuits (C-R), and other protections, they need to be installed near the MOS RELAY to be effective. Adding protection elements may result in a slow reset time, so adjust them according to the actual situation before use.

Note: When developing designs using this product, perform the expected performance of the equipment under the operating conditions recommended by the guidelines in this document. Continuous use under heavy loads (including, but not limited to, the application of high temperatures/current/voltage and significant changes in temperature, etc.) may result in deterioration of the reliability of this product.



Recommended Soldering Conditions

(a) Infrared reflow soldering :

- Peak reflow soldering : 260°C or below (package surface temperature)
- Time of peak reflow temperature : 10 sec
- Time of temperature higher than 230°C : 30-60 sec
- Time to preheat temperature from 180~190°C : 60-120 sec
- Time(s) of reflow : Two
- Flux : Rosin flux containing small amount of chlorine (The flux with a maximum chlorine content of 0.2 Wt% is recommended.)

Recommended Temperature Profile of Infrared Reflow



(b) Wave soldering :

- Temperature : 260°C or below (molten solder temperature)
- Time : 10 seconds or less
- Preheating conditions : 120°C or below (package surface temperature)
- Time(s) of reflow : One
- Flux : Rosin flux containing small amount of chlorine (The flux with a maximum chlorine content of 0.2 Wt% is recommended.)

(c) Cautions :

- Fluxes : Avoid removing the residual flux with freon-based and chlorine-based cleaning solvent.
- Avoid shorting between portion of frame and leads.



RESTRICTIONS ON PRODUCT USE

APSEMI Co. and its subsidiaries and affiliates (collectively "APSEMI") reserve the right to make changes to all information contained in this document relating to hardware, software, and systems (collectively "Products").

No information in this document may be reproduced without the prior written permission of APSEMI. Even with APSEMI's written permission, this document may only be reproduced if it is guaranteed to be unaltered or missing.

APSEMI assumes no responsibility for unintended uses of the product:

Unintended uses include, but are not limited to, equipment used in nuclear facilities, equipment used in the aerospace industry, medical equipment, automobiles, trains, ships, and other transportation equipment, traffic signaling equipment, equipment used for the control of combustion or explosions, safety devices, elevators and escalators, equipment used in electrical power-related applications, and equipment used in financial-related applications.

APSEMI assumes no responsibility for the product if you use it for any purpose other than the specific purpose described in this document.

- The information contained herein is provided only as a guide for the use of the product.

APSEMI assumes no responsibility for infringement of third party patents or any other intellectual property rights that may result from the use of the product. This document does not grant any license, express or implied, estoppel or otherwise, to any intellectual property.

- GaAs (Gallium Arsenide) is used in products and is harmful to humans. Inadvertent ingestion or absorption of GaAs can harm the human body, so handle the product with care and do not break, cut, crush, grind, chemically dissolve, or otherwise expose GaAs in the product.

- Please be aware of environmental issues and use products in compliance with all applicable laws and regulations governing the inclusion or use of controlled substances, including but not limited to the EU RoHS Directive. APSEMI assumes no responsibility for damages or losses resulting from non-compliance with applicable laws and regulations.